



NSD/SRT/2007/2015 – 16/

November, 05/2015

**NOTICE INVITING QUOTATION FOR SUPPLY OF PROPS (AS PER
DESIGNS ATTACHED) FROM 19TH NOVEMBER TO 25TH NOVEMBER, 2015
IN THE BAL SANGAM, 2015**

The undersigned for and on behalf of the Director, National School of Drama, New Delhi-1, invites quotations in the form of sealed tenders for the above mentioned work.

i) Quotations (financial) are invited for supply of props from 18th November to 25th Nov, 2015 (as per list attached) in the **Bal Sangam** (A festival of Indian performing folk and traditional arts presented by children, practicing these arts from different regions of the country) in sealed cover addressed to the Registrar, National School of Drama, Bahawalpur House, Bhagwandas Road, New Delhi- should be submitted on or before 09.11.15 by 3.00 a.m.

ii) Sealed quotations will be opened in the TIE basement of National School of Drama, Bahawalpur House, Bhagwandas Road, New Delhi-110 001 in the presence of such supplier who may like to be present on 09.11.15 at 4.00 p.m.

TERMS AND CONDITIONS

1. The applicant should have experience of making props for Theatre field and Ambience design for organizations. The applicants should furnish photos and necessary copies of the Work order or any other relevant proof of his/her work along with quotation.
2. The props should positively be installed by 19th November, 2015 and removed from the premises of NSD after 26th November, 2015.
3. Quotation should be itemized for sale or hire.

Financial bid:

1. It will clarify all financial expectations inclusive of all kind of taxes, transportations, lesion fee or any other such expenses the supplier can so imagine.
2. Please specify applicable taxes and rate of tax.
3. Payments in respect of this service contract are subjected to Tax Deduction at Source as per the provisions of Income Tax Act, 1961.
4. Addition/alteration if any suggested by the Designer should be carried out.
5. Director National School of Drama reserve the right to accept/reject any quotation without assigning any reason.

Total item sheets attached are 20(Twenty pieces) and all the items should be on Rainbow colour

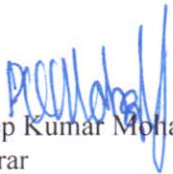
Pradeep Kumar Mohanty
Registrar

Item No 1

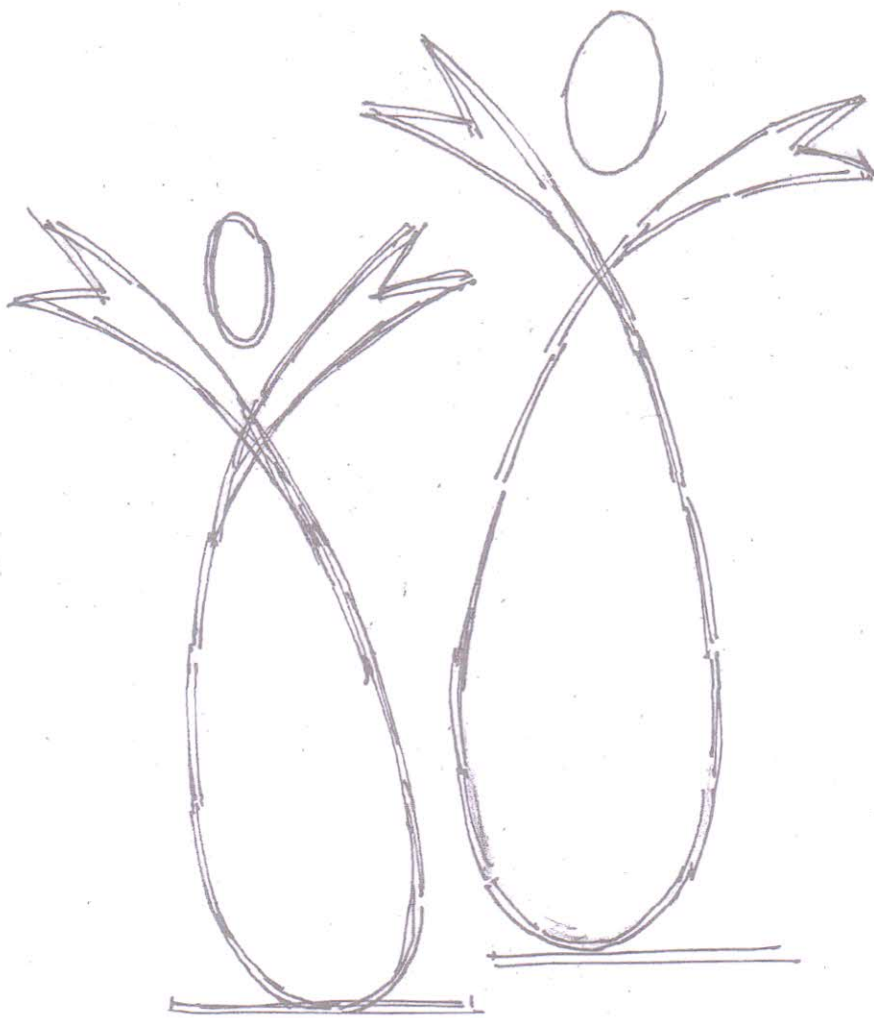

Dancing Dolls: 3D
Rainbow Colours

Hieght :

3' = 3pcs

3.5' = 3pcs

6.5' = 3 pcs

Item Sheet 2

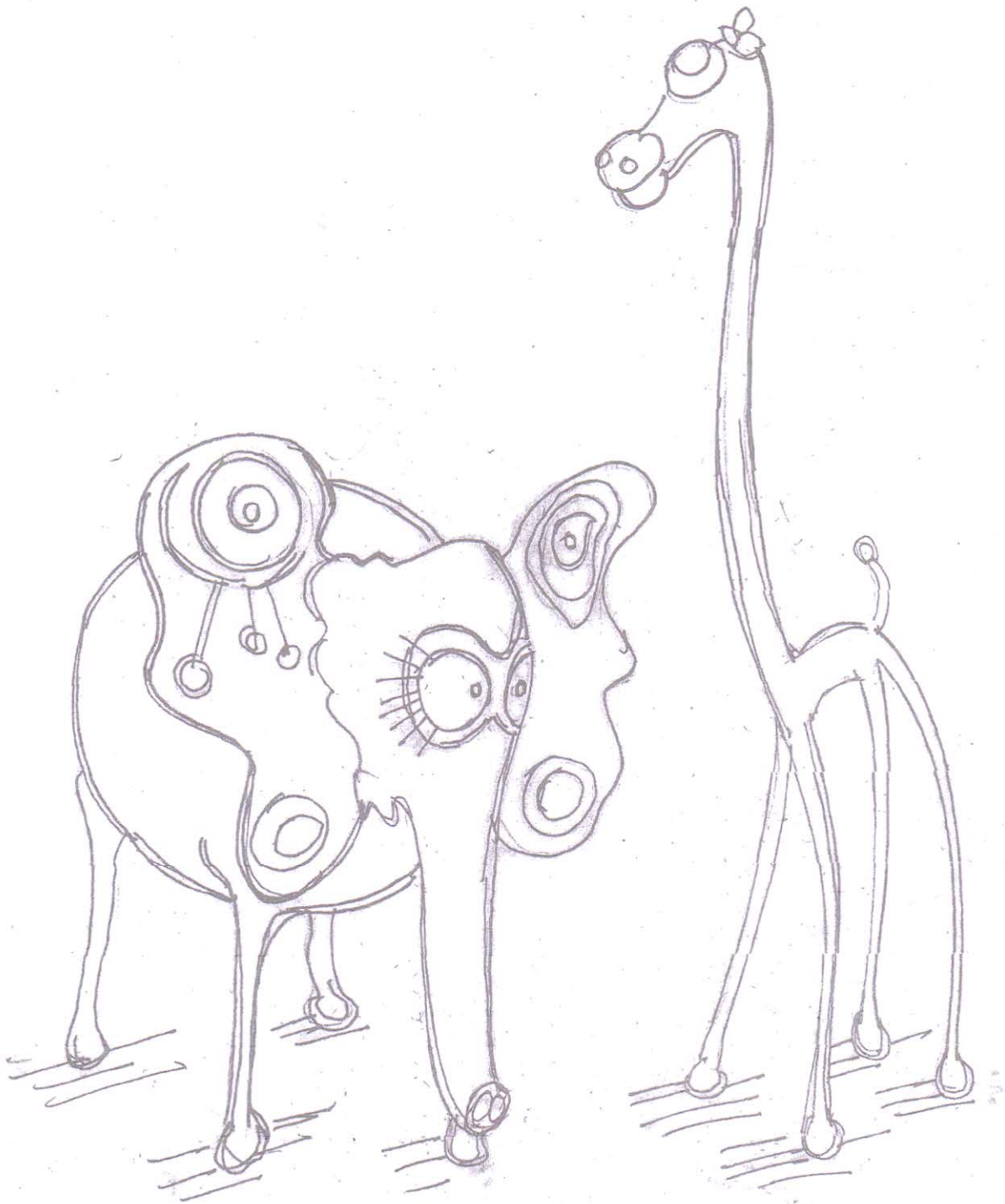

Paper mache & bamboo animals : 3D
Rainbow Colours

Hieght :

3' = 3pcs

3.5' = 3pcs

6.5' = 3 pcs

Item sheet 3



**Paper mache & bamboo animals : 3D
Rainbow Colours**

Height :

3' = 2pcs

3.5' = 2pcs

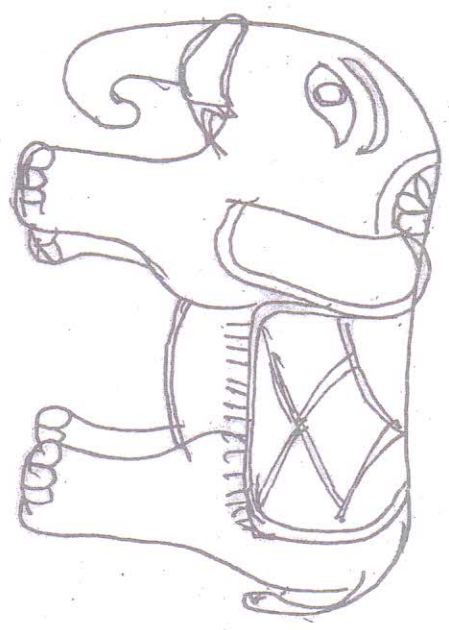

W



Paper Mache and bamboo animals; rainbow colours; 3D

hieght : 3 to 4 ft. 2 pcs each

Item Sheet 5

Dancing Dolls; 3D Hieght approx 7'

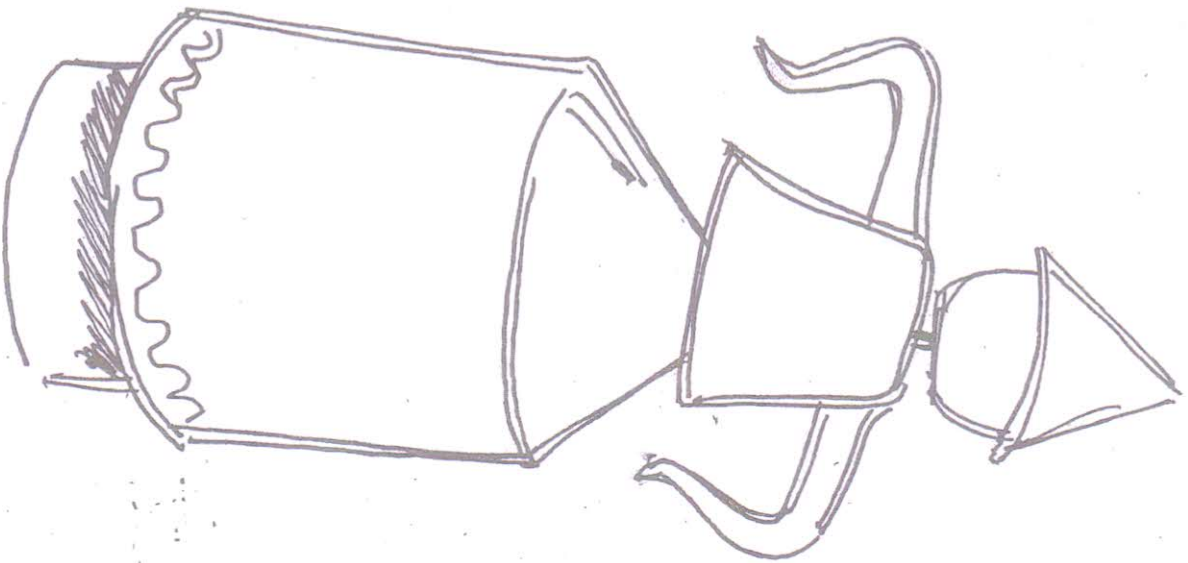
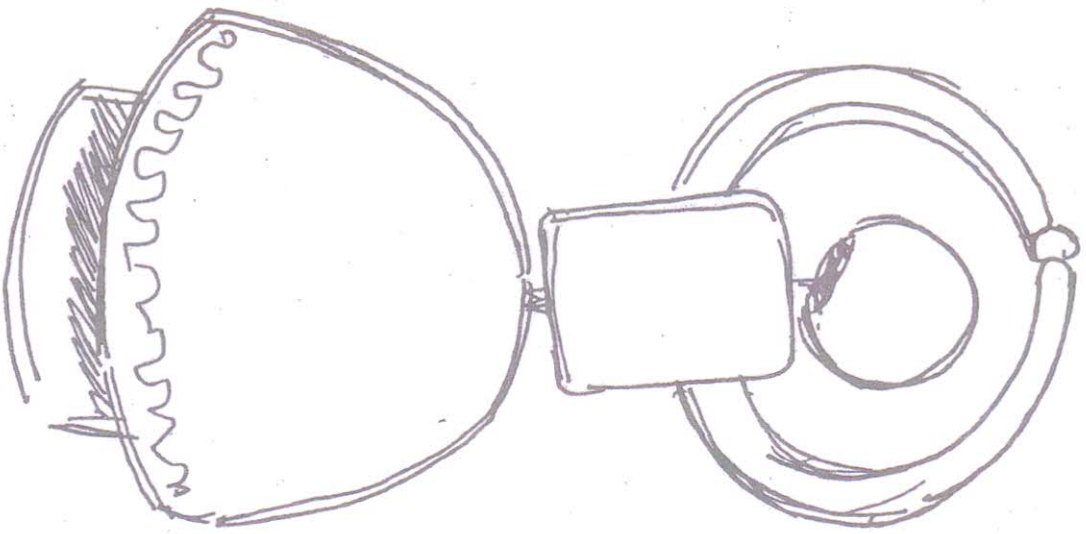

Item Sheet 6

Dancing Dolls; 3D Hieght approx 7'

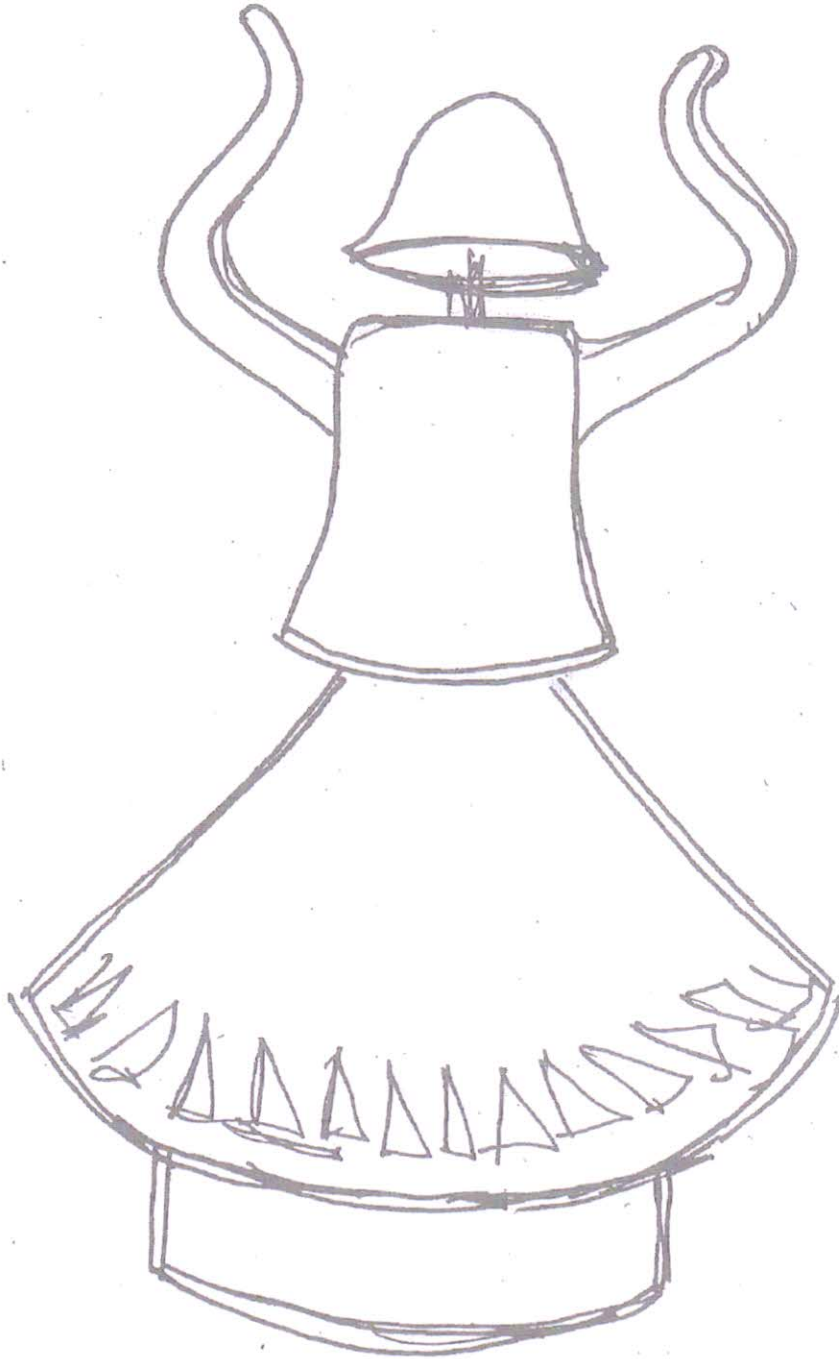

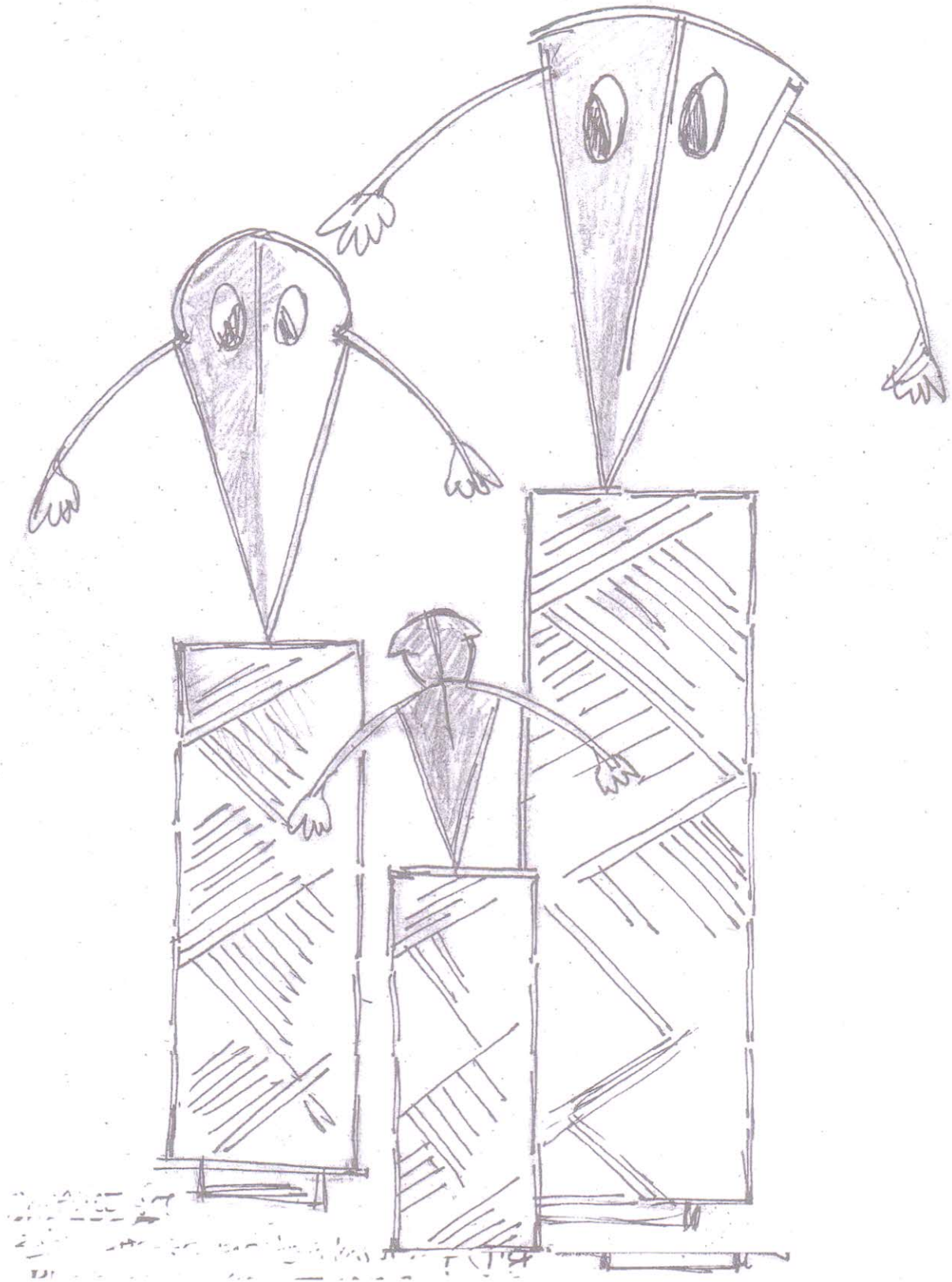

Balancing Dolls : 3D

Rested on Pedestals

heights : 10' , 15', 20'

Item Sheet 8

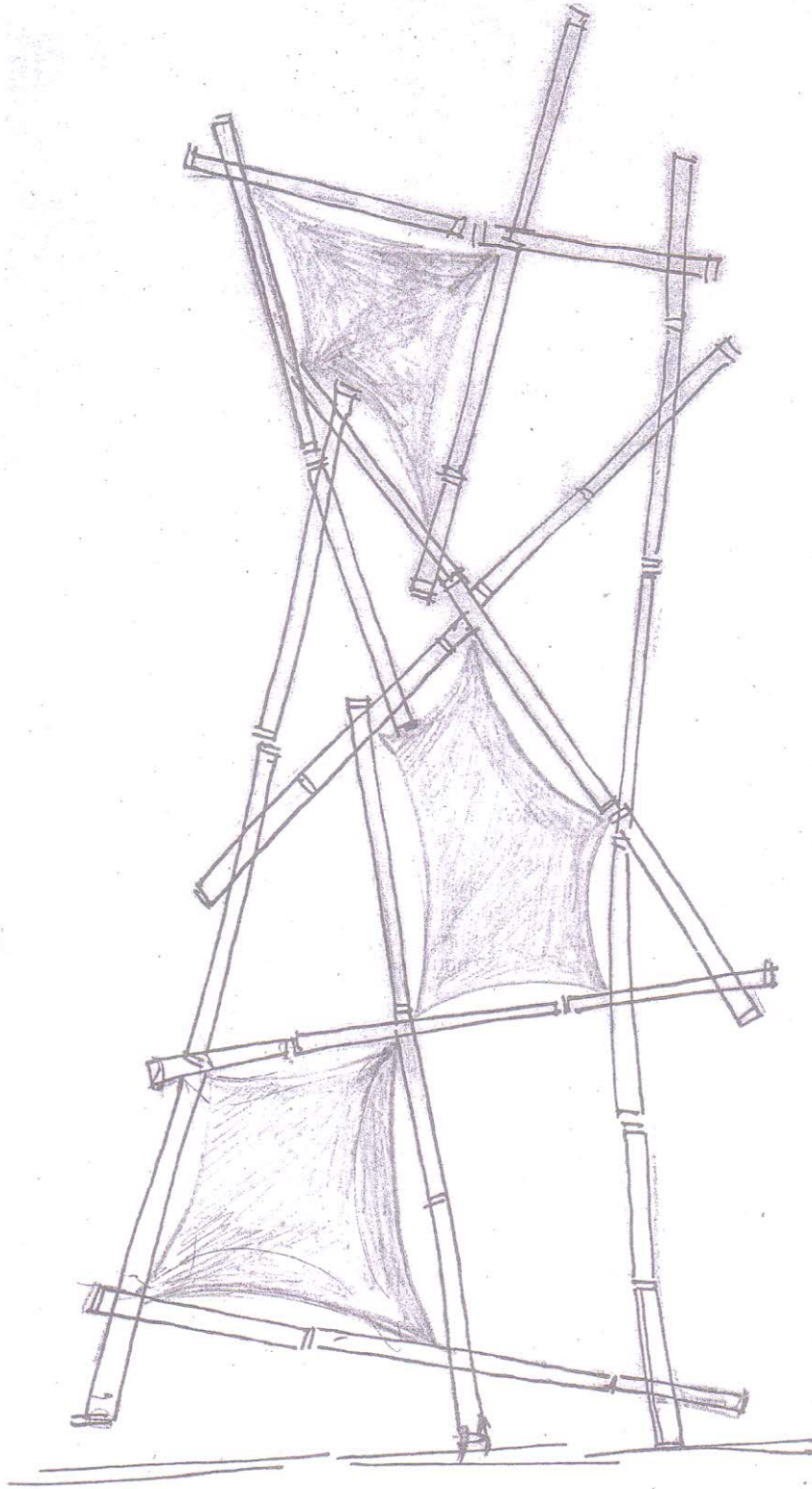

Bamboo Screens, weaved with colourful fabrics;

To be used as barricades and installation items

Minimum size will be 6' X 3'

Rate to be per square feet

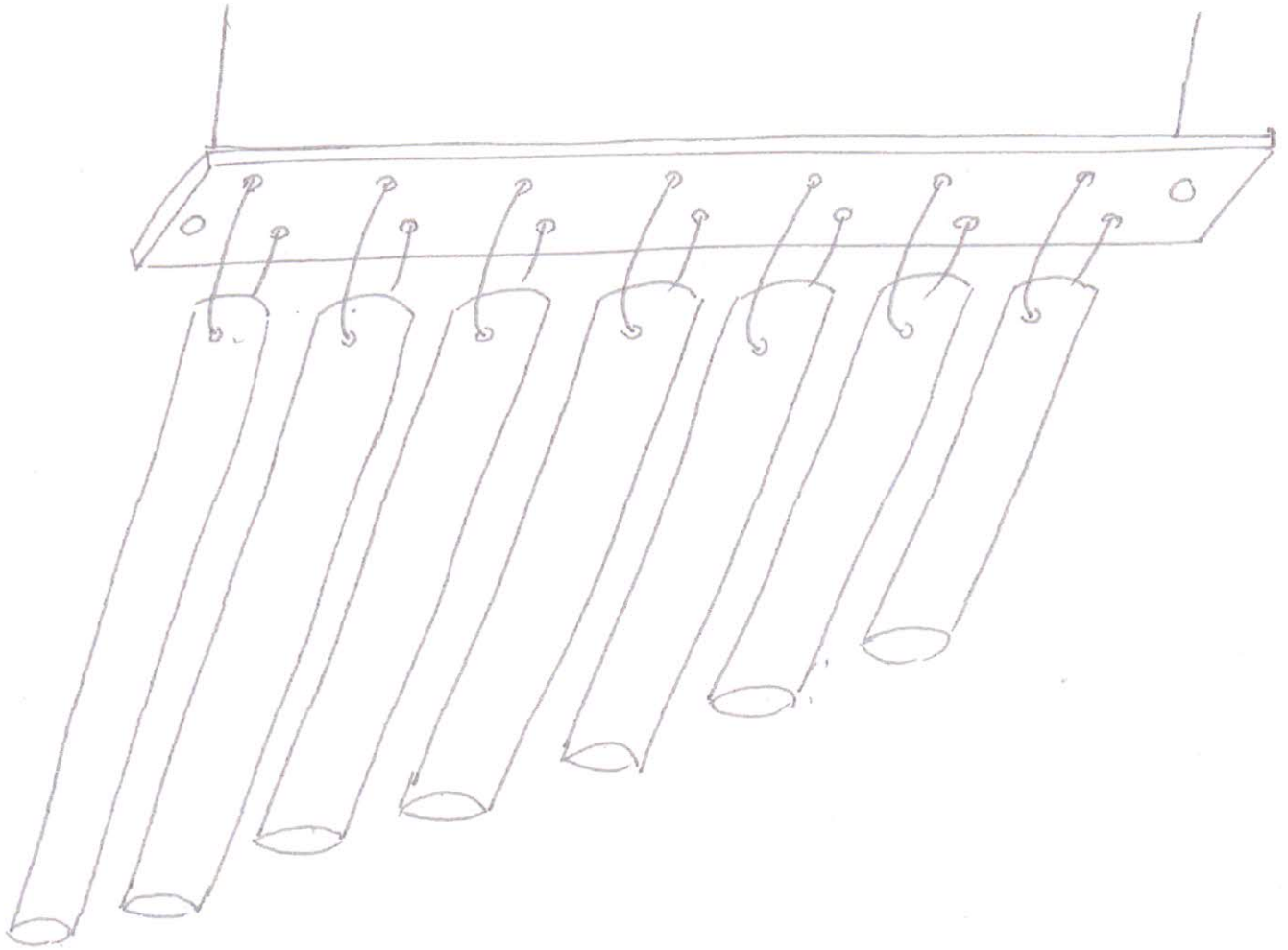

Item Sheet 9 : Musical Pipes ; 4pcs

Pipes of 1' to 4' length hanging from board

Pipe Dia size: 2" to 3"

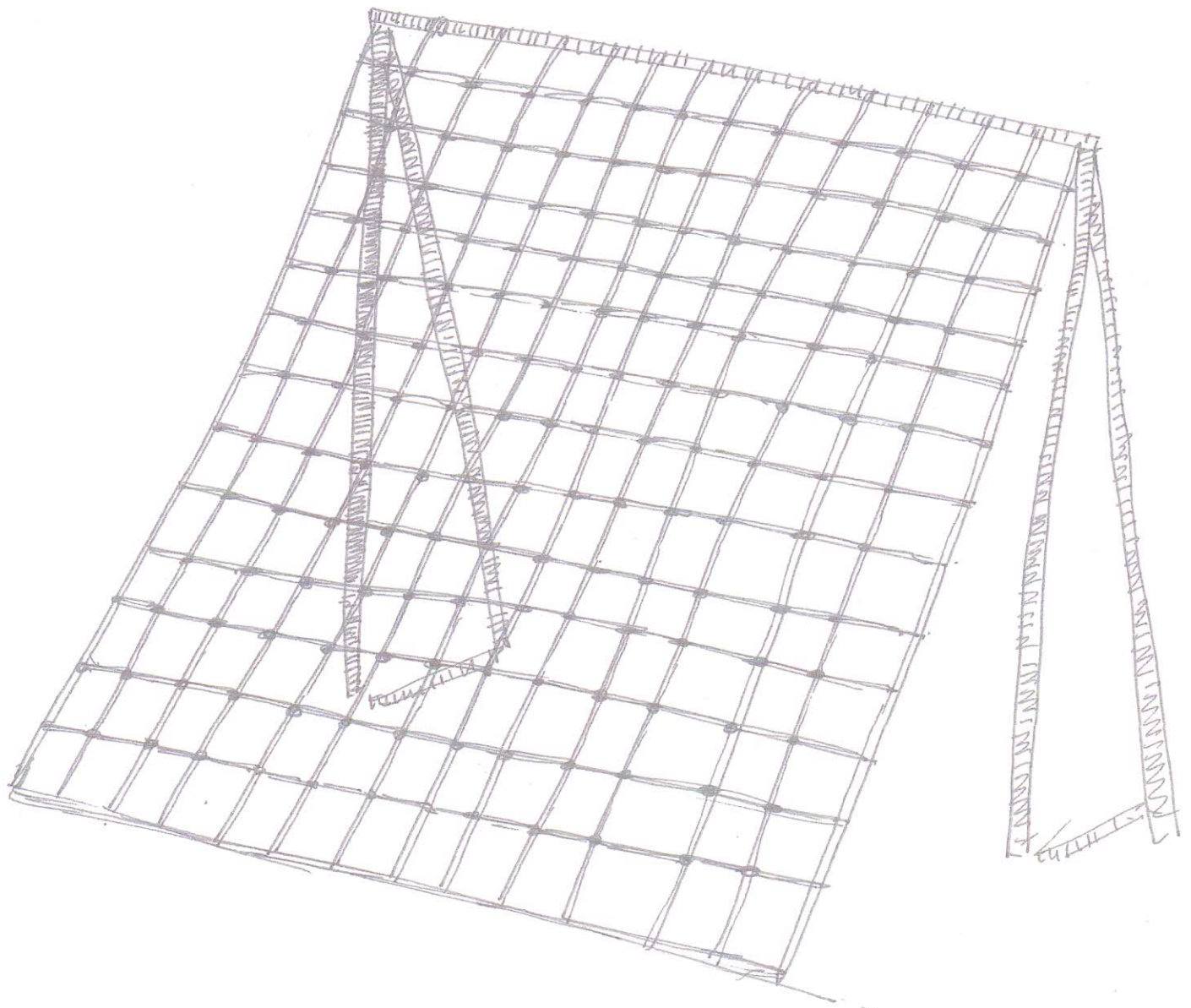

**Item Sheet 10 : Rope Adventure net : Net on both sides.
Colourfull Ropes: 9" square 1" thickness rope.
Center Hieght = 15' Width 10'**

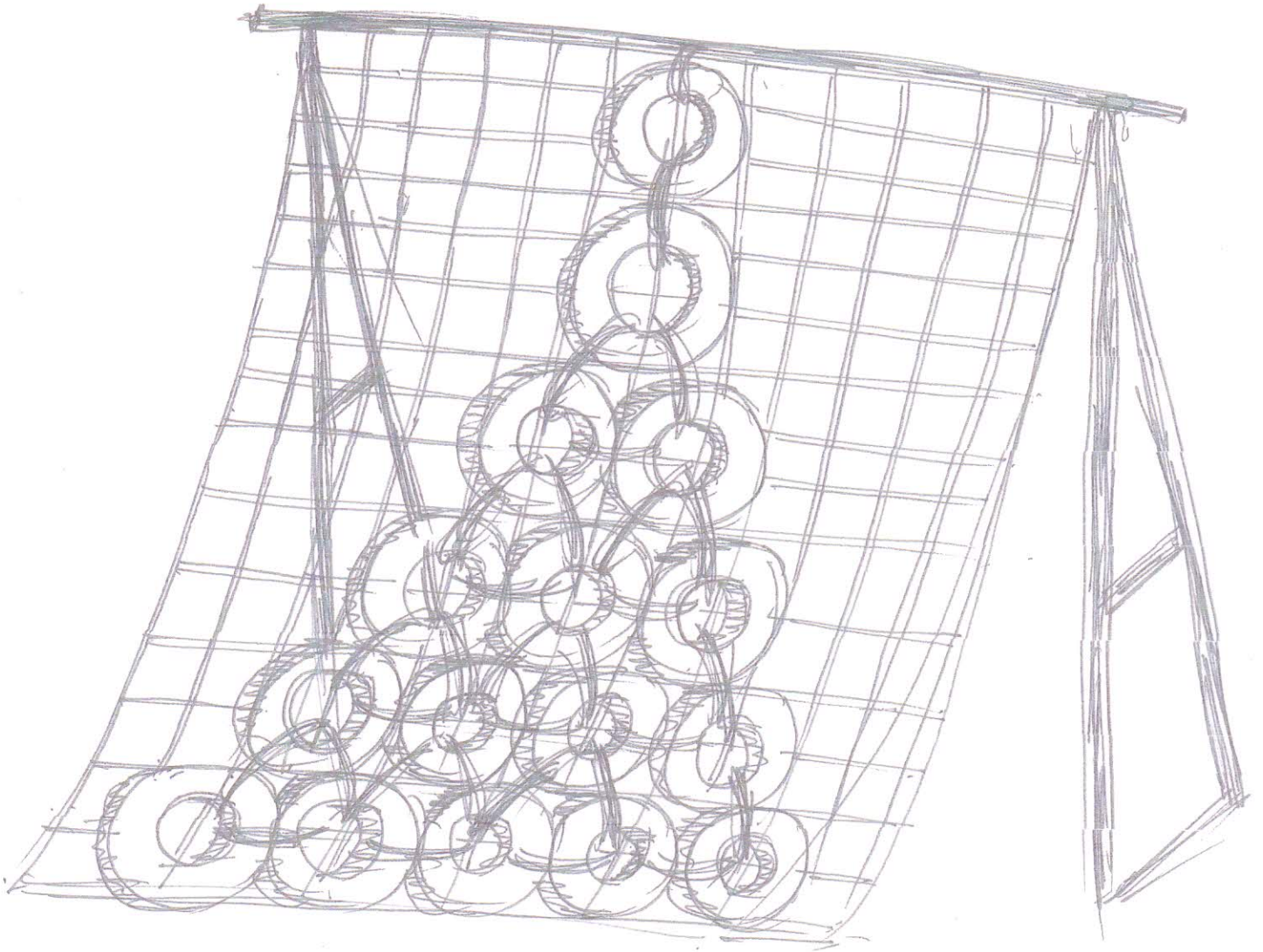

Item sheet 11 : Rope and Tyre adventure net; 1 pc

Hieght 12' Width 8' Rainbow colours

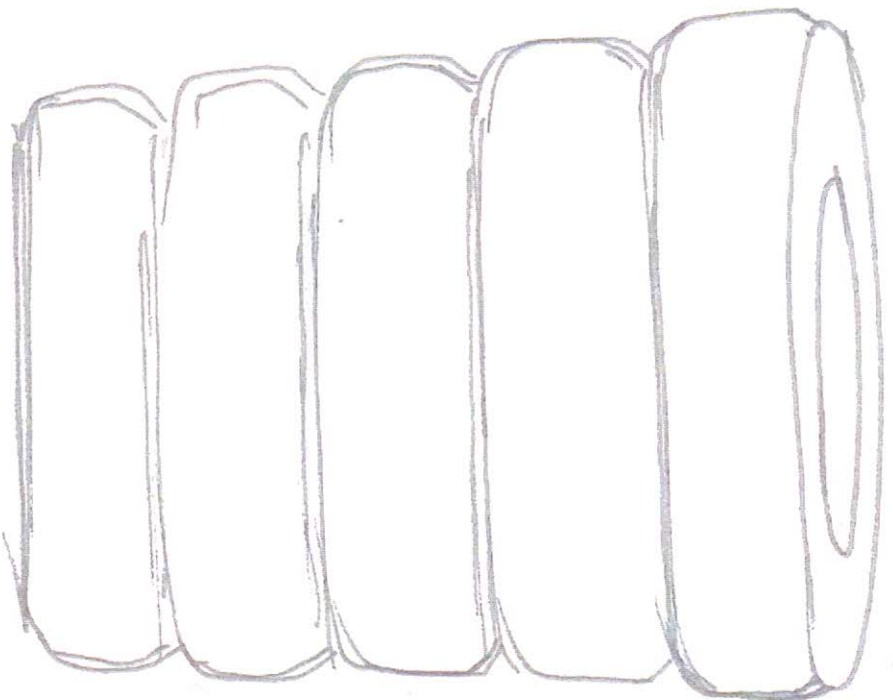
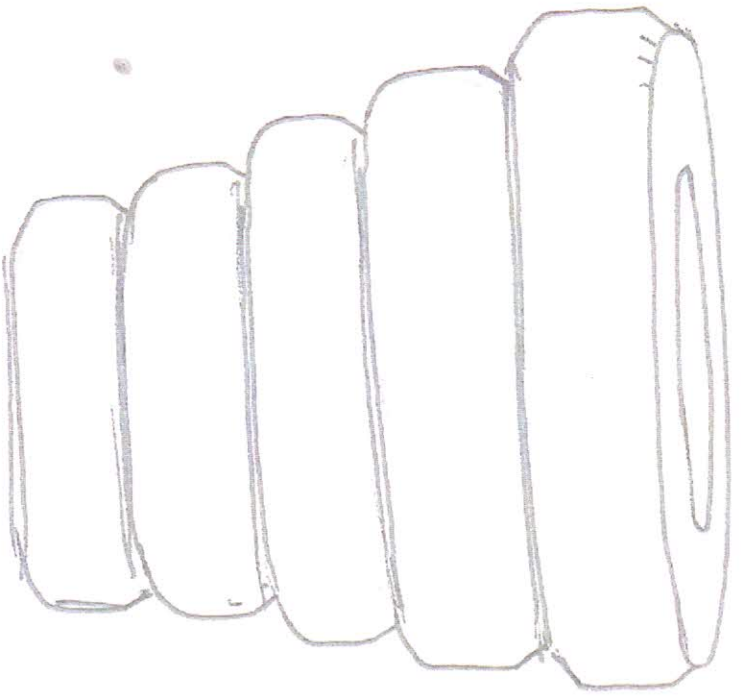

Item sheet 12 : Tyre Dust Bins; 10 pc

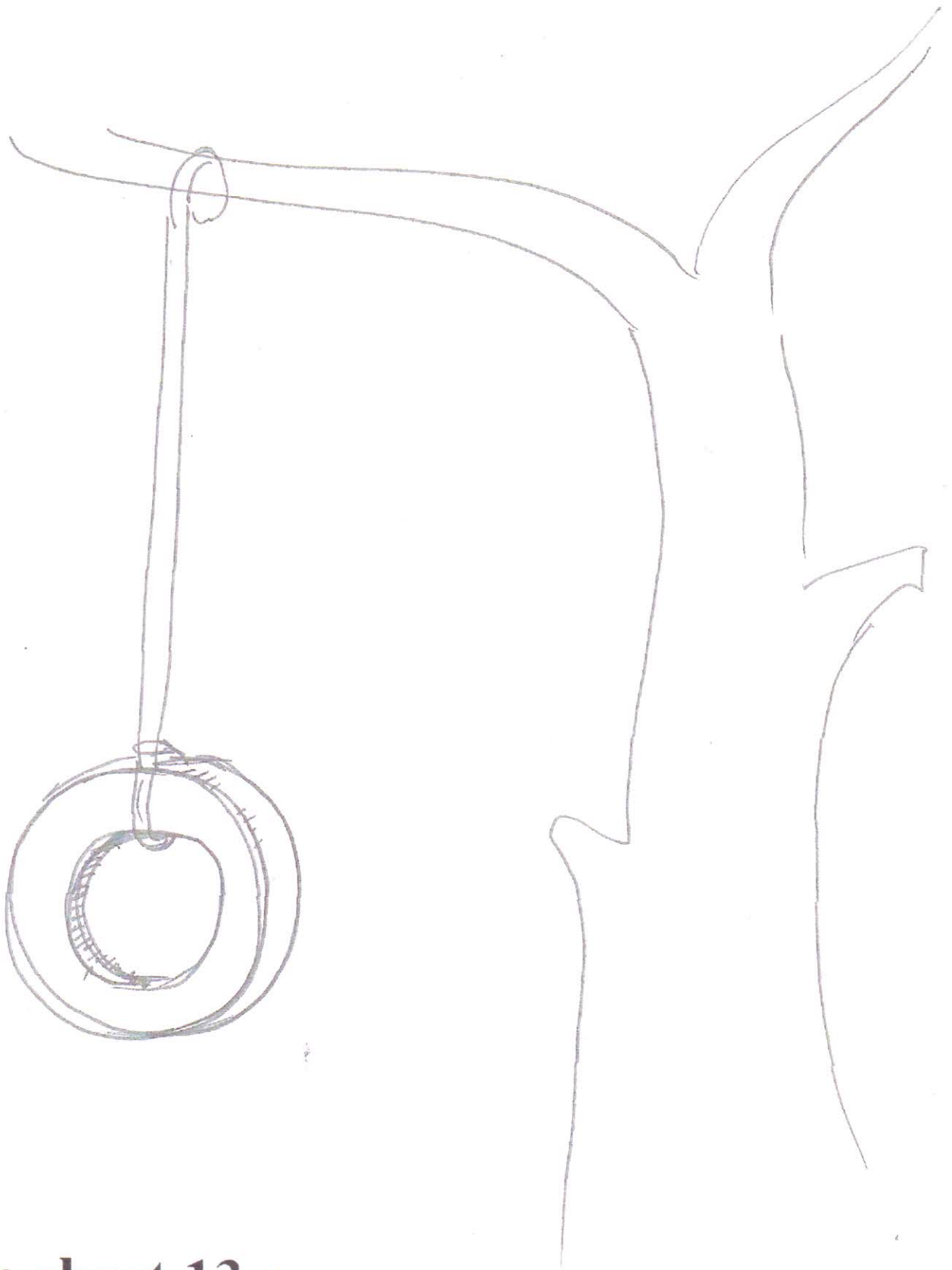

Item sheet 13 :
Rope and Tyre swing 3 pc
Rainbow colours

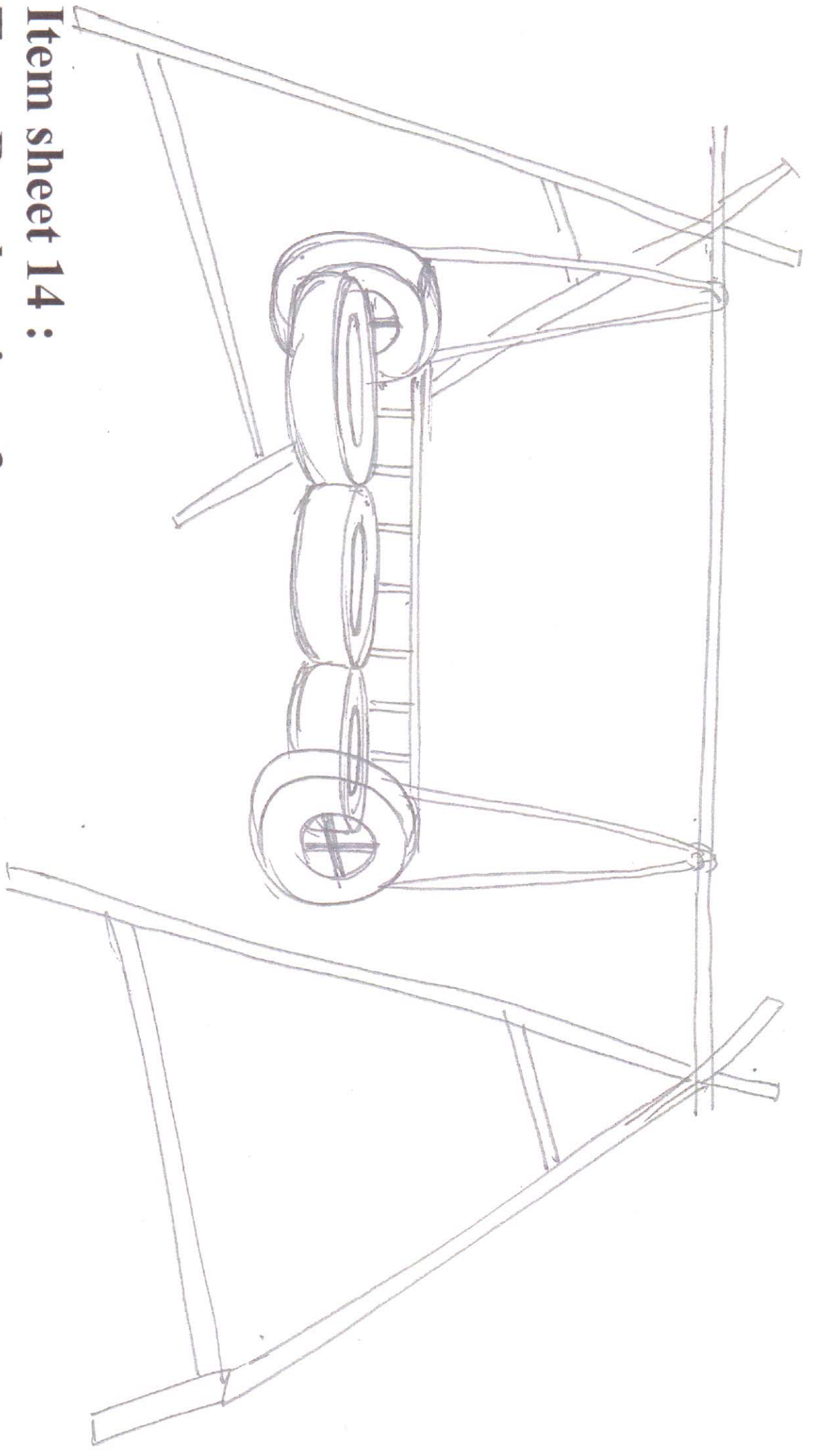

Item sheet 14 :
Tyre Bench swing 3 pc
Rainbow colours

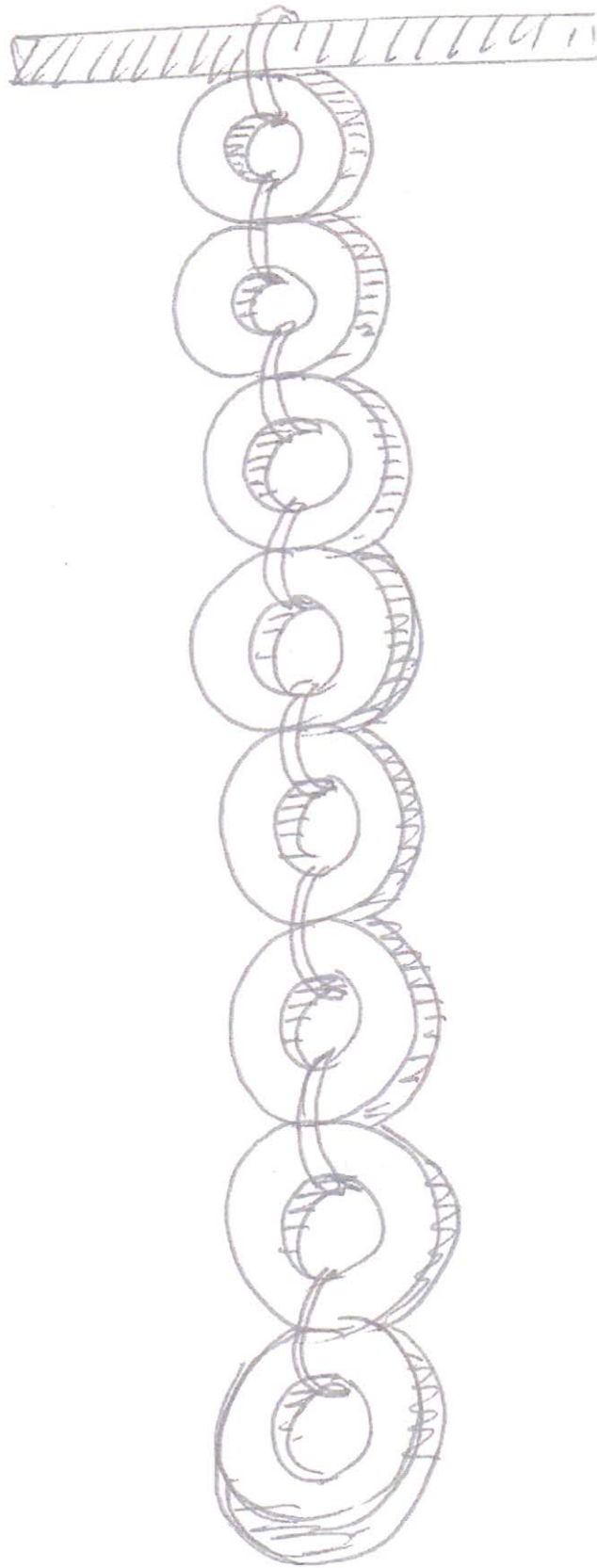

Item sheet 15 :
Tyre climb 3 pc
Rainbow colours

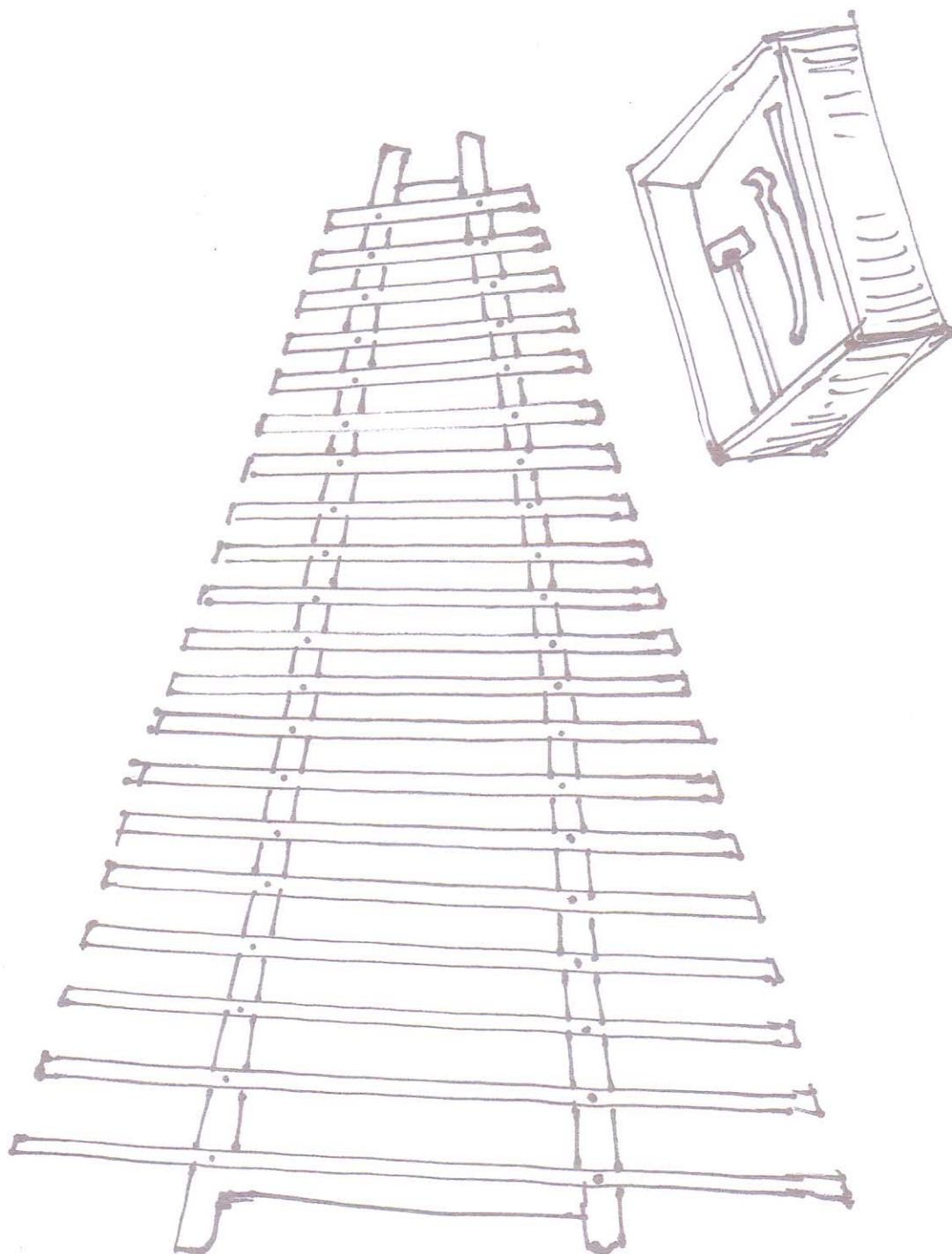

Item sheet 16 :
one inch pipe musical on stands 3 pc
Rainbow colours

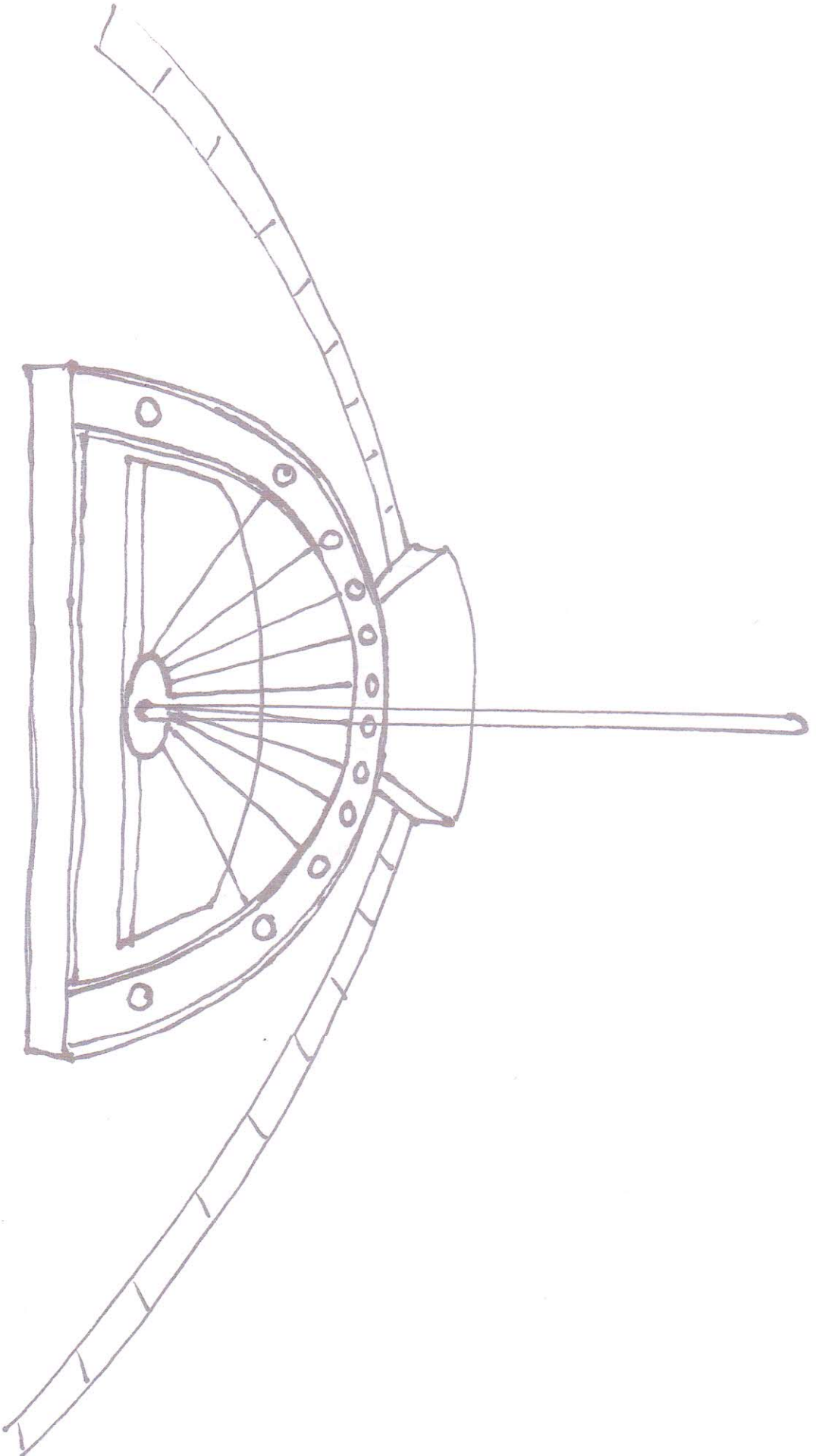

Item sheet No. 17; Solar watch ; 6' X 6'

Item sheet No. 18; tyre bridge

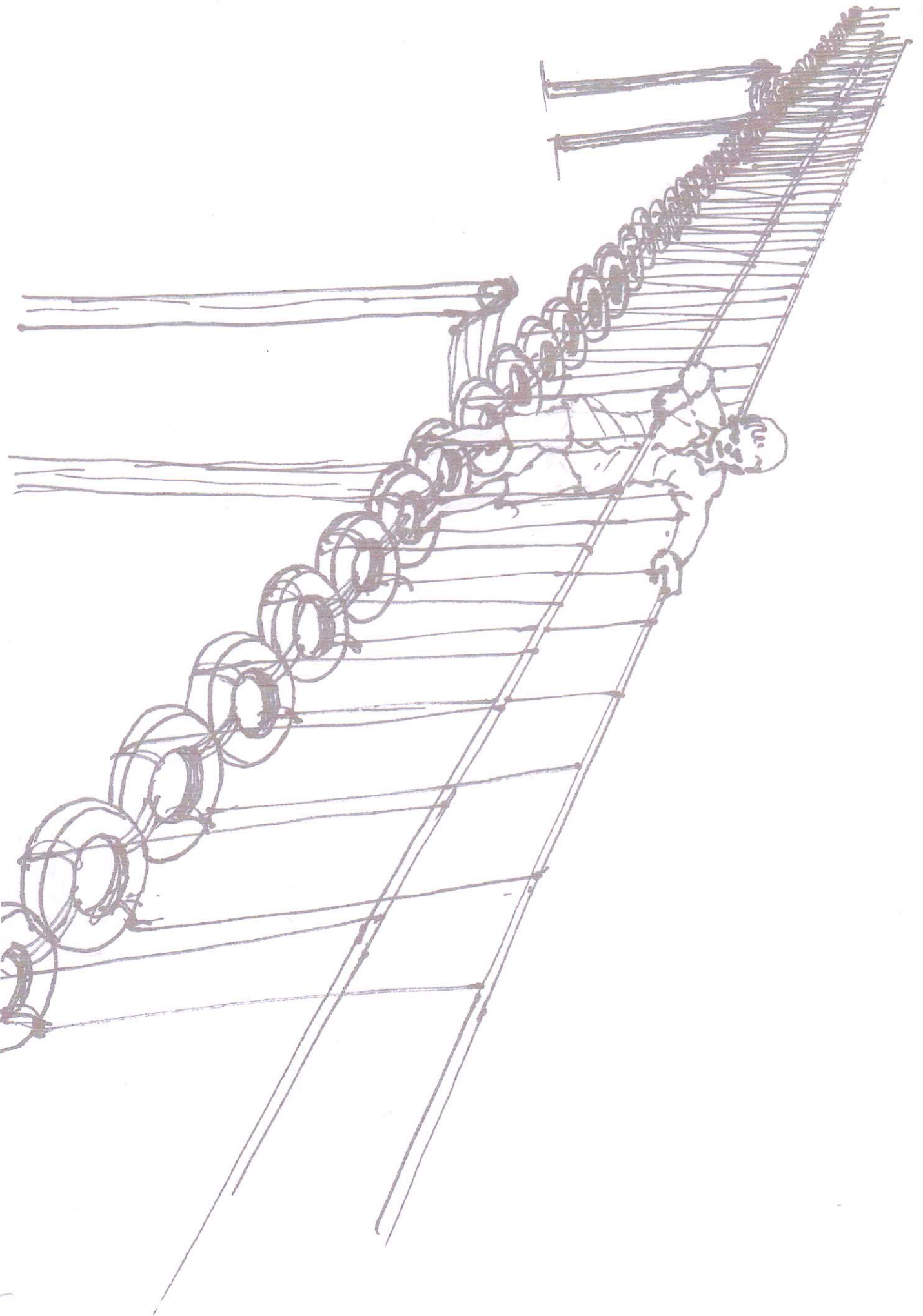

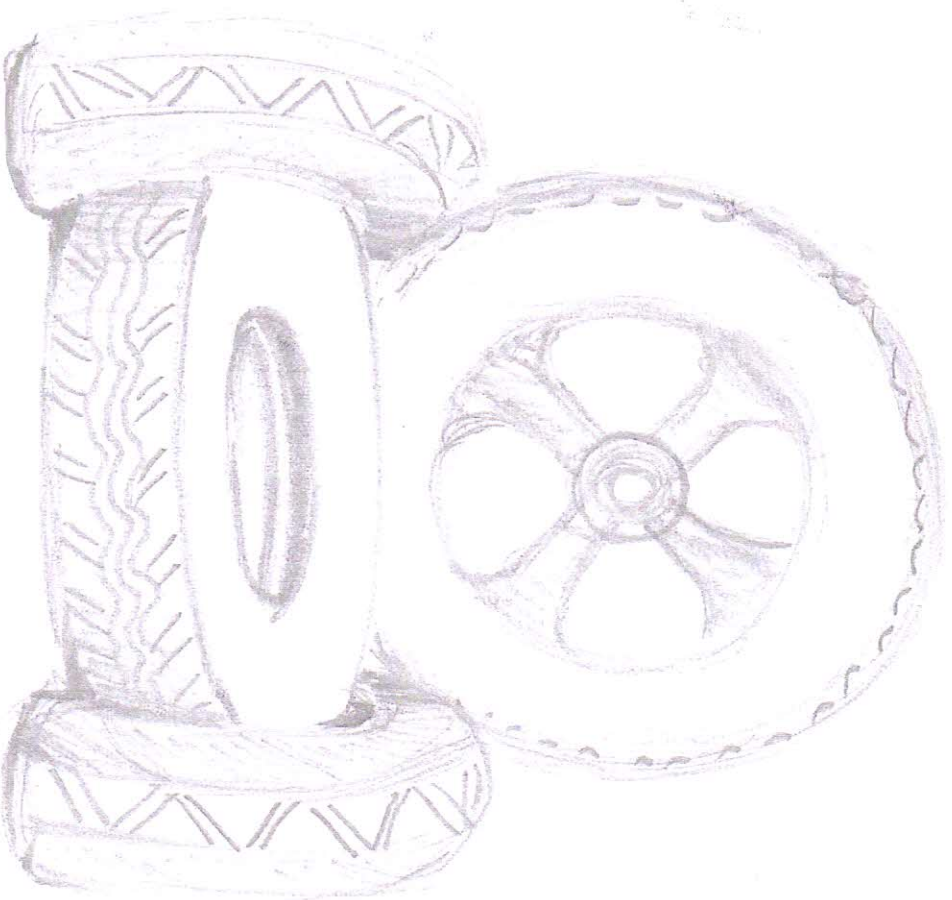
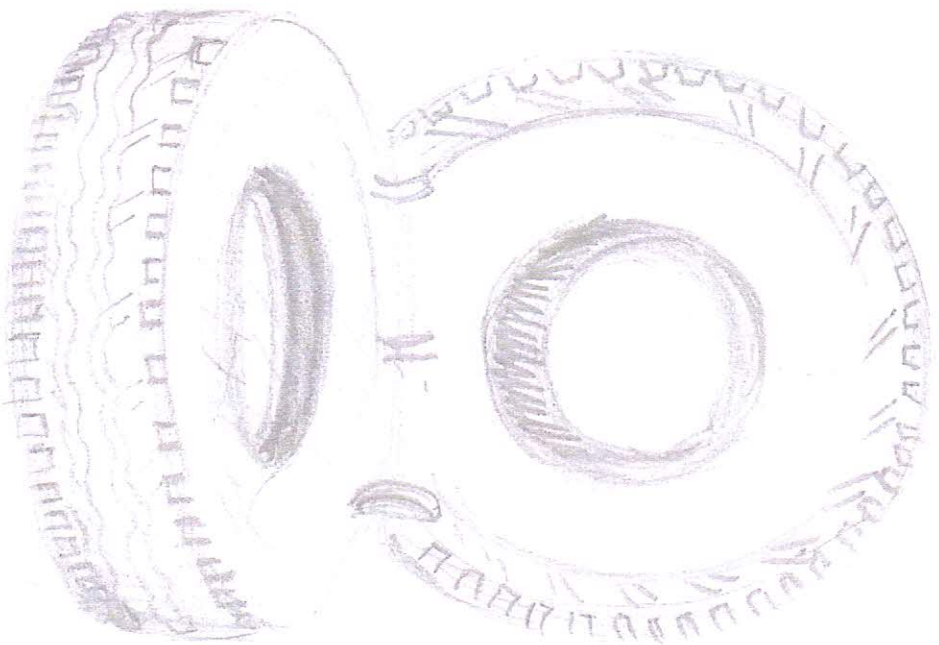

Item sheet No. 19; tyre seats ; 12 pcs
Rainbow colours

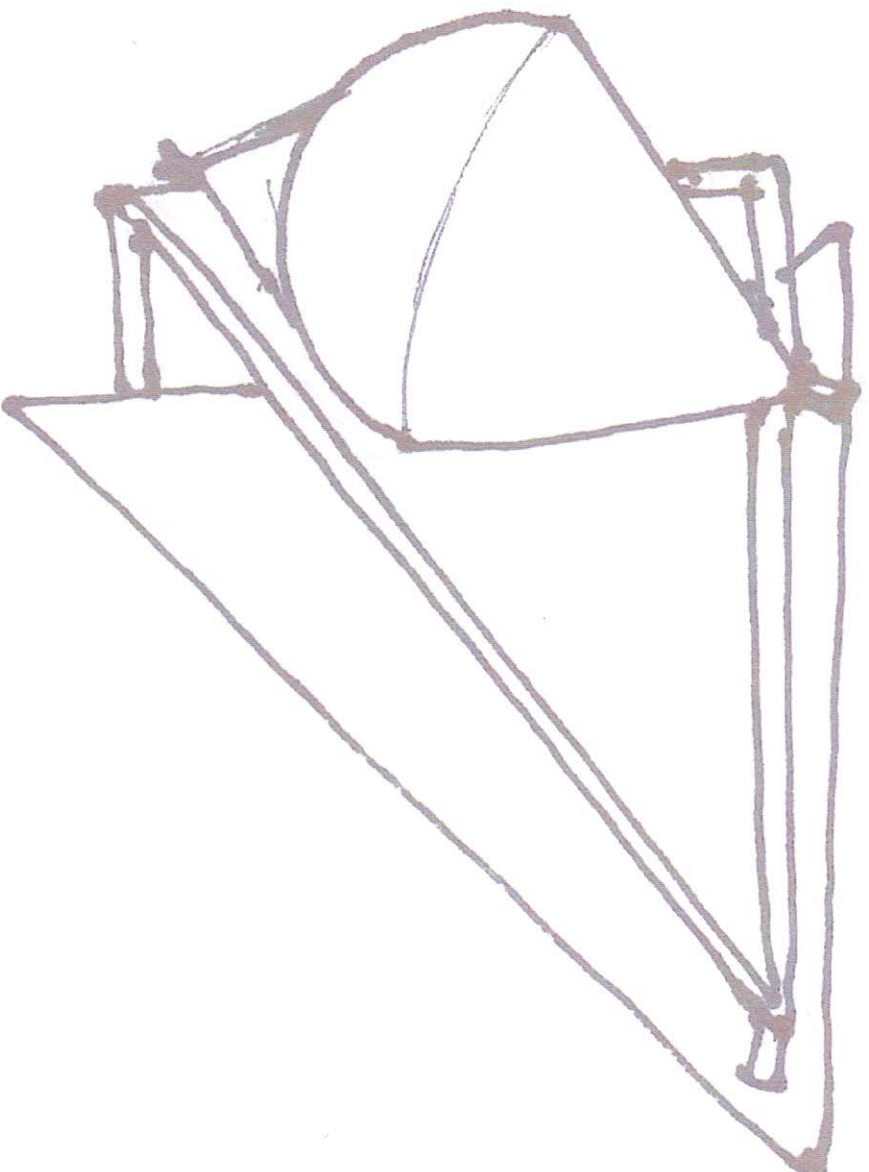

Item sheet No.20 ; Weight
moving against gravity;
one pcs 4'